

# EVS Ordering Guide

Choose one of the package options shown, or....create your own!

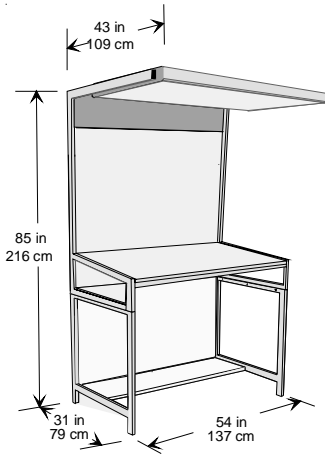

**EVS-1**  
Model: EVS-1

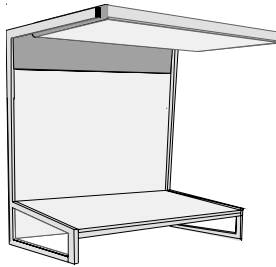

**EVS-B**  
Model: EVS-1/NS

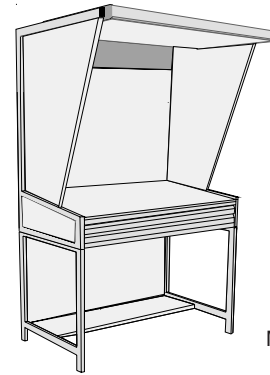

**EVS-C**  
Models: EVS-1/2F  
SW-EVS

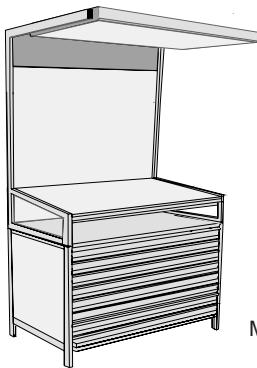

**EVS-D**  
Model: EVS-1/FD\*

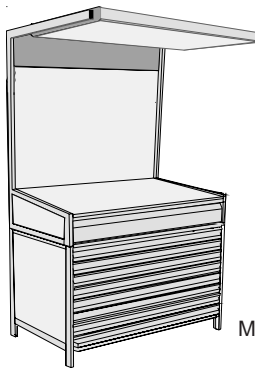

**EVS-E**  
Model: EVS-1/FD/1F\*

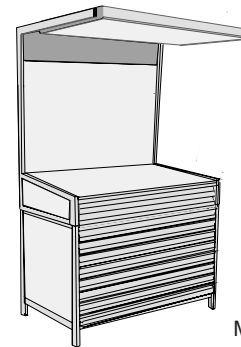

**EVS-F**  
Model: EVS-1/FD/2F\*

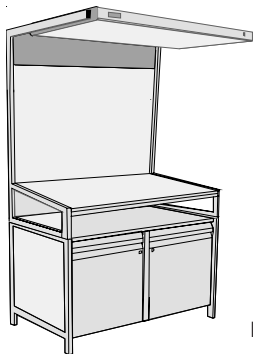

**EVS-G**  
Model: EVS-1/SC

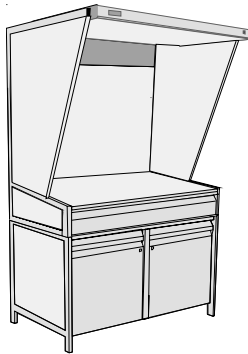

**EVS-H**  
Models: EVS-1/SC/1F  
SW-EVS

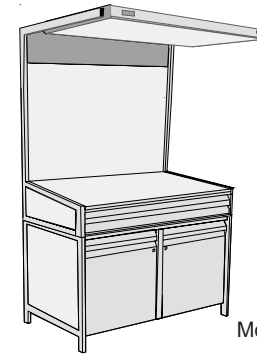

**EVS-I**  
Model: EVS-1/SC/2F

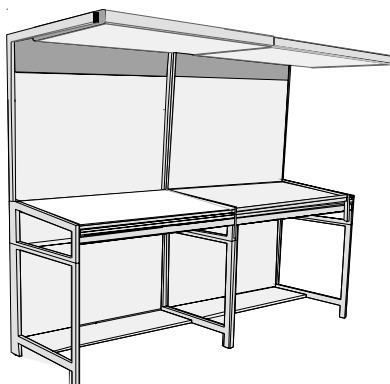

**EVS-J**  
Model: EVS-2

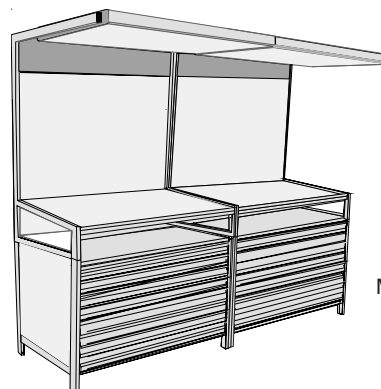

**EVS-K**  
Model: EVS-2/FD\*\*

Please add crating fee charges:  
\* \$125.00  
\*\* \$250.00

**GTI Graphic Technology, Inc.**

# EVS-2540 Ordering Guide

Choose one of the package options shown, or....create your own!

## System Components

H: 41" x W: 42" x D: 26.5"



Model EVS-2540

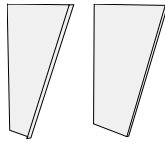

Model SW-2540

## Table Risers

H: 8" x W: 42" x D: 26.5"

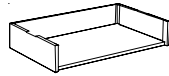

Model TS-2540

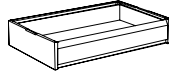

Model 1F-2540

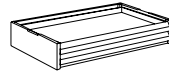

Model 2F-2540

## Floor Stands & Storage

H: 32" x W: 42" x D: 26.5"



Model FS-2540

Table riser optional  
Height is adjustable 32" - 48"

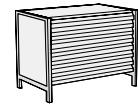

Model FD-2540\*

Requires table riser option

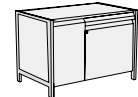

Model SC-2540

Requires table riser option

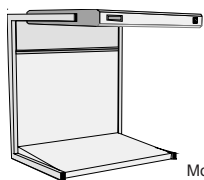

**40-A**

Model: EVS-2540

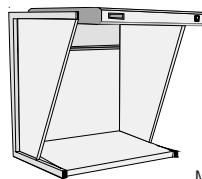

**40-B**

Models: EVS-2540  
SW-2540

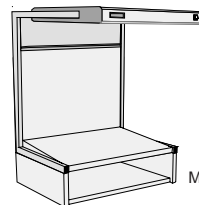

**40-C**

Models: EVS-2540  
TS-2540

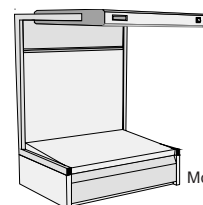

**40-D**

Models: EVS-2540  
1F-2540

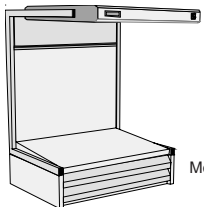

**40-E**

Models: EVS-2540  
2F-2540

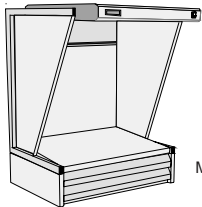

**40-F**

Models: EVS-2540  
2F-2540  
SW-2540

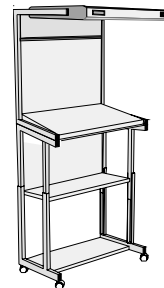

**40-G**

Model: EVS-2540/FS

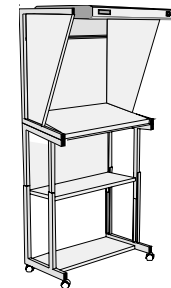

**40-H**

Models: EVS-2540/FS  
SW-2540

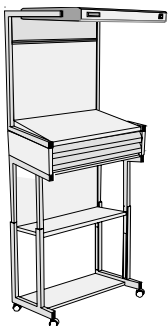

**40-I**

Models: EVS-2540/FS  
2F-2540

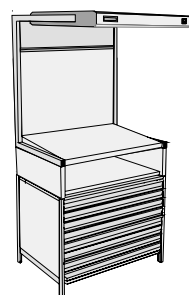

**40-J**

Models: EVS-2540  
TS-2540  
FD-2540\*

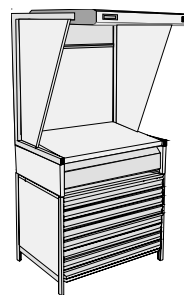

**40-K**

Models: EVS-2540  
1F-2540  
FD-2540\*  
SW-2540

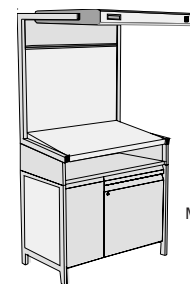

**40-L**

Models: EVS-2540  
TS-2540  
SC-2540

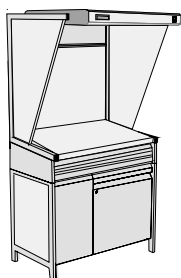

**40-M**

Models: EVS-2540  
2F-2540  
SC-2540  
SW-2540

\*Please add crating fee charge of \$125.00

**GTI Graphic Technology, Inc.**

211 Dupont Avenue, P.O. Box 3138 | Newburgh, New York 12550 | Tel: 845-562-7066 | Fax: 845-562-2543 | Web: www.gtilite.com