

EVS-2028 Ordering Guide

Choose one of the package options shown, *or....create your own!*

System Components	Table Risers/Flat File Drawers	Floor Stand
H: 37" x W: 30" x D: 21.5"	H: 8" x W: 30" x D: 21.5"	H: 32" x W: 30" x D: 21.5"
Model EVS-2028	Model SW-2028	Model FS-2028
		<i>Table riser optional Height is adjustable 32" - 48"</i>
	Model TS-2028	
	Model 1F-2028	
	Model 2F-2028	

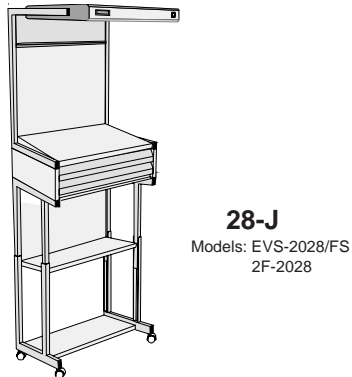
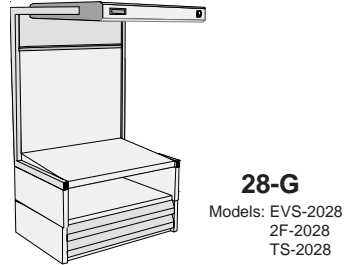
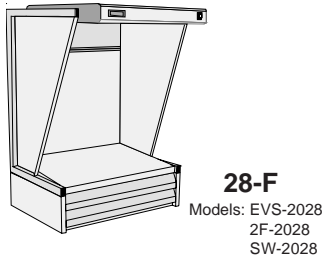
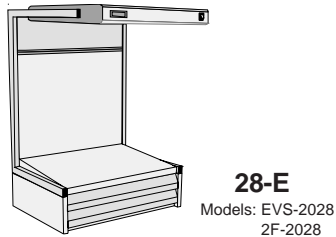
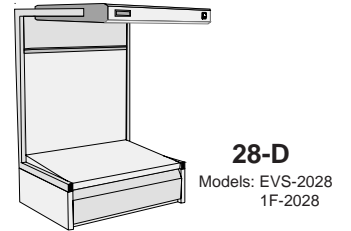
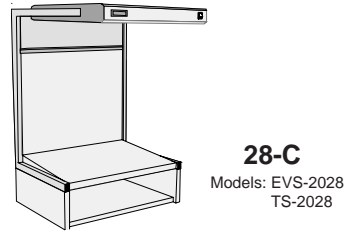
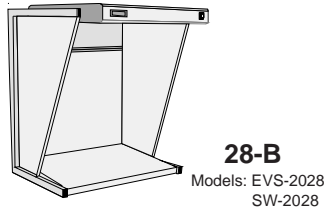
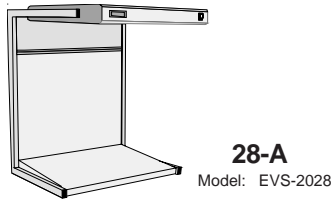

EVS-2540 Ordering Guide

Choose one of the package options shown, or....create your own!

System Components

H: 41" x W: 42" x D: 26.5"

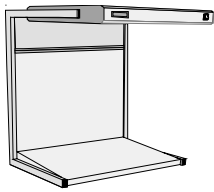

Model EVS-2540

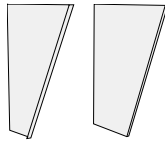

Model SW-2540

Table Risers

H: 8" x W: 42" x D: 26.5"

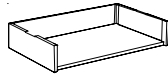

Model TS-2540

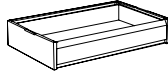

Model 1F-2540

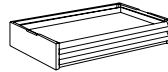

Model 2F-2540

Floor Stands & Storage

H: 32" x W: 42" x D: 26.5"



Model FS-2540

Table riser optional
Height is adjustable 32" - 48"

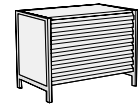

Model FD-2540*

Requires table riser option

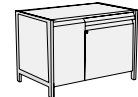

Model SC-2540

Requires table riser option

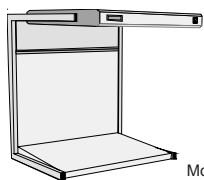

40-A

Model: EVS-2540

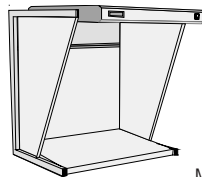

40-B

Models: EVS-2540
SW-2540

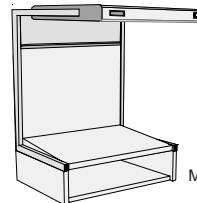

40-C

Models: EVS-2540
TS-2540

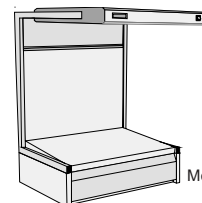

40-D

Models: EVS-2540
1F-2540

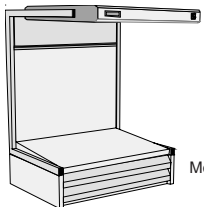

40-E

Models: EVS-2540
2F-2540

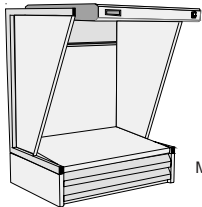

40-F

Models: EVS-2540
2F-2540
SW-2540

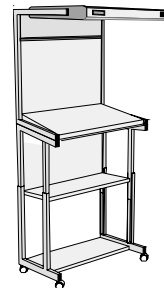

40-G

Model: EVS-2540/FS

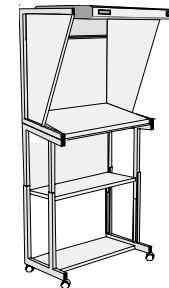

40-H

Models: EVS-2540/FS
SW-2540

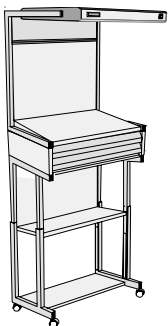

40-I

Models: EVS-2540/FS
2F-2540

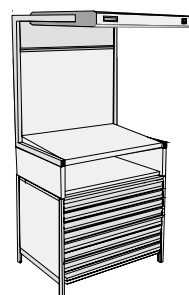

40-J

Models: EVS-2540
TS-2540
FD-2540*

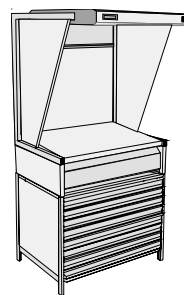

40-K

Models: EVS-2540
1F-2540
FD-2540*
SW-2540

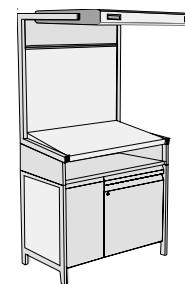

40-L

Models: EVS-2540
TS-2540
SC-2540

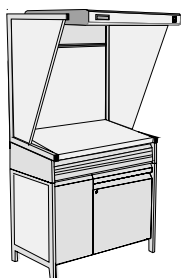

40-M

Models: EVS-2540
2F-2540
SC-2540
SW-2540

*Please add crating fee charge of \$125.00

GTI Graphic Technology, Inc.

211 Dupont Avenue, P.O. Box 3138 | Newburgh, New York 12550 | Tel: 845-562-7066 | Fax: 845-562-2543 | Web: www.gtilite.com

EVS-3052 Ordering Guide

Choose one of the package options shown, or....create your own!

System Components

H: 45.5" x W: 54" x D: 31" (base)
Depth of Luminaire: 42"

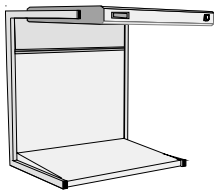

Model EVS-3052

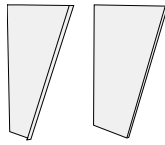

Model SW-3052

Table Risers/Flat File Drawers

Height: 8"

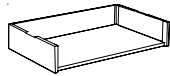

Model TS-3052

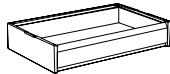

Model 1F-3052

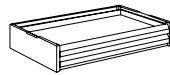

Model 2F-3052

Floor Stands & Storage

Height: 32"



Model FS-3052

Table riser optional
Height is adjustable 32" - 48"

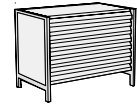

Model FD-3052*

Requires table riser option

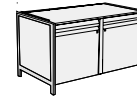

Model SC-3052

Requires table riser option

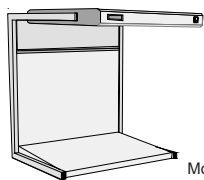

52-A

Model: EVS-3052

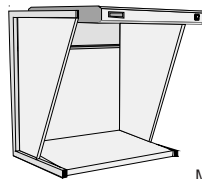

52-B

Models: EVS-3052
SW-3052

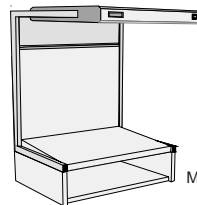

52-C

Models: EVS-3052
TS-3052

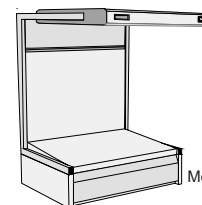

52-D

Models: EVS-3052
1F-3052

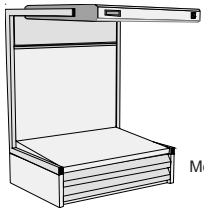

52-E

Models: EVS-3052
2F-3052

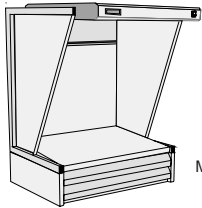

52-F

Models: EVS-3052
2F-3052
SW-3052

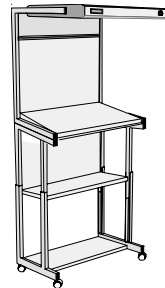

52-G

Model: EVS-3052/FS

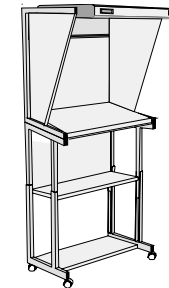

52-H

Models: EVS-3052/FS
SW-3052

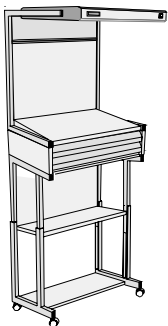

52-I

Models: EVS-3052/FS
2F-3052

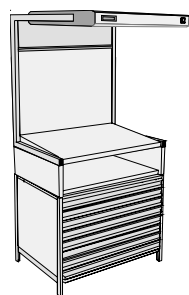

52-J

Models: EVS-3052
TS-3052
FD-3052*

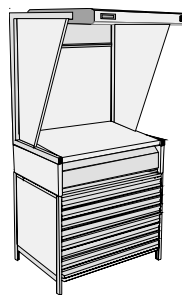

52-K

Models: EVS-3052
1F-3052
FD-3052*
SW-3052

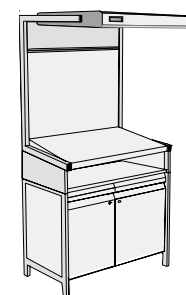

52-L

Models: EVS-3052
TS-3052
SC-3052

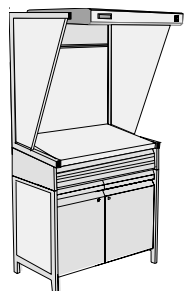

52-M

Models: EVS-3052
2F-3052
SC-3052
SW-3052

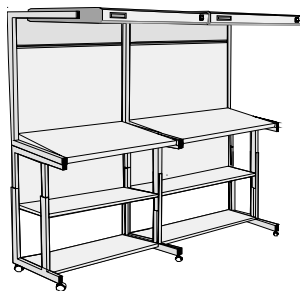

52-N

Model: EVS-30106/FS

*Please add crating fee charge of \$125.00

GTI Graphic Technology, Inc.